

2m/70cm/23cm Tri-band High Performance
Gain Vertical Antenna

X6000/X6000W

FRP Outershell. DC Ground structure.

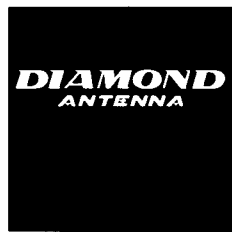

Operation Instructions

●Assembly

Upper element is settled in upper FRP outershell. Shake upper FRP outer-shell lightly to take out upper element. Note; Do not pull out lower element as it is fixed in lower FRP outer-shell.

1) Connect upper and lower elements.

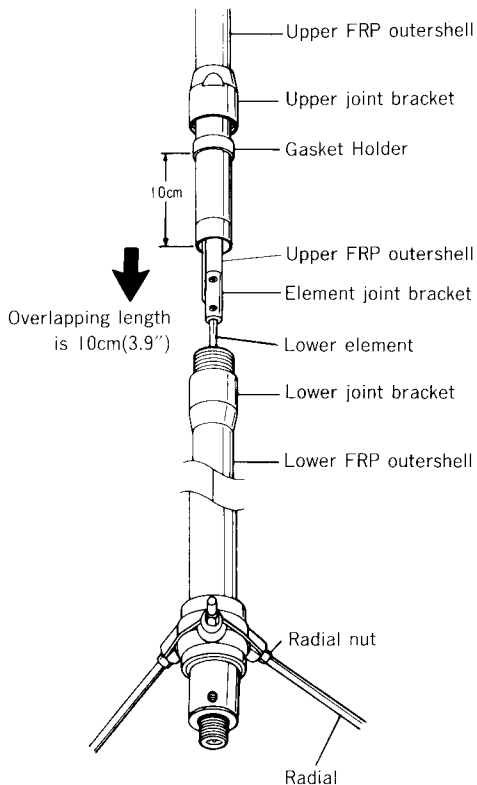

2) Put lower element into element joint bracket thoroughly and fix it.

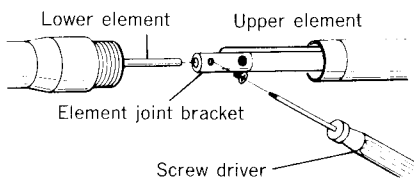

3) After fixing the element at element joint bracket, connect upper and lower outershell with outershell joint bracket.

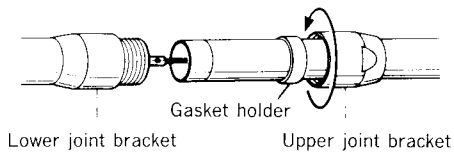

4) Fasten outershell joint bracket with wrench.

Fasten until there is no gap between the outershells.

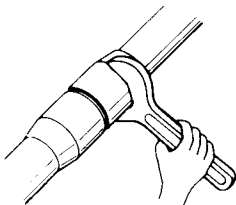

5) Install three radial elements as shown in the illustration.

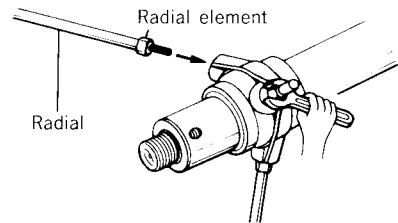

6) Attach mast brackets on support pipe and fix them. Then connect coaxial cable (with N connector) to feedpoint section through support pipe.

Fix support pipe and feedpoint section of the antenna with lock screw by aligning the holes at the bottom of feedpoint section and upper part of the pipe.

Note; Be sure to set mast bracket below lock screw, otherwise support pipe may not be detached because the pipe is being dented.

7) Attach assembled antenna on mast by whole balance into account as shown in the following figure. And turn coaxial cable once to make a loop at right below the antenna to escape excess load from the cable.

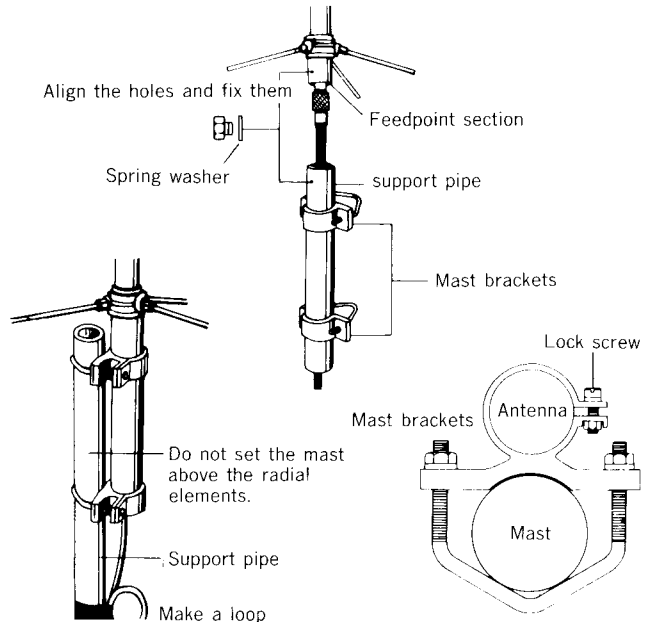

●Adjustment

The antenna is completely adjustment free, if vswr of the antenna is extraordinary high, most likely, it is due to coaxial cable and connector contact, or connector soldering problem. And be sure to use 50 Ω coaxial cable to feed the antenna.

●Note

- 1) N type connector is being used in the feedpoint connection of the antenna. Since N connector is relatively complicated compare with conventional UHF type connector, utmost care has to be taken to handle connector cable connection.
- 2) In installing the antenna, turn coaxial cable once at right below the antenna to escape load from the cable. This is to avoid disconnecting center conductor of N connector and especially important when thick diameter coaxial cable is being used to feed the antenna.
- 3) Though the antenna is DC ground structure, circuit across the inner conductor and outer conductor is open-circuit when measured by a volt-ohm meter. If it is close-circuit, confirm coaxial cable connections well.

●Specifications

Frequency : 144-146MHz, 430-440MHz, 1260-1300MHz
Gain : 6.5dB(2m), 9.0dB(70cm), 10.0dB(23cm)
Impedence : 50ohms
VSWR : Less than 1.5:1
Max. power rating : 100W(2m/70cm), 60W(23cm)
Rated wind velocity : 50m/sec.(112.5MPH)
Mast diameter accepted : 30-62 ϕ (1 1/5" to 2 2/5")
Length : 3.05m
Radial length : approx.52cm(20 1/2")
Weight : 1.8kg(3.96lbs.)
Connector : N
Type : Two 5/8 wavelength C-Load phased vertical(2m),
Five 5/8 wavelength C-Load phased vertical
(70cm)
Six 5/8 wavelength C-Load phased vertical (23cm)

FOR YOUR SAFETY

Read the following safety precautions before start assembling the antenna.

- Assemble the antenna on the ground or wide and flat place such as on balcony before installation.
- Do not assemble or install the antenna on a place where you can not have enough distance from any electric power lines.
- Do not install the antenna on a rainy or windy day.
- Do not attempt to install the antenna only by yourself. Installing the antenna alone on the roof may lead you dangerous accident. Always ask your friends for help installing the antenna.
- Do not use iron or aluminum ladder at a reachable distance from any electric power lines.
- Do not install the antenna on a mast which is not grounded properly.
- Do not have your family members or friends touch or come close to the antenna, unless they have realized its potential danger.

TO AVOID FATAL ACCIDENT

- Do not attempt to sustain the antenna, or any part of support structure if it begins to fall down. Let it fall by itself.
- Do not attempt to remove or restore the antenna or any part of support structure if it touches a electric power line by chance. Let it be as it is, do not touch it, and call your local electric power company immediately.

IN CASE OF AN ACCIDENT

- Do not touch a person or an animal who is or seems to be in contact with the antenna or any support structure which is fallen on a live electric power line. Touching one may lead you to be electrocuted.
- Do not attempt to separate a person or an animal who is or seems to be in contact with the antenna or any support structure which is fallen on a live electric power line by yourself. Call or have someone call a police officer, ambulance, doctor immediately.

ANTENNA INSTALLATION PRECAUTIONS

To determine antenna installation location, there are several factors to be taken into account. First thing is antenna propagation direction to specific target stations. As to whether there is any obstacles such as tall buildings on the line of sight. Next is specific installation location. As to whether specific location is adequate in terms of antenna support and surrounding safety.

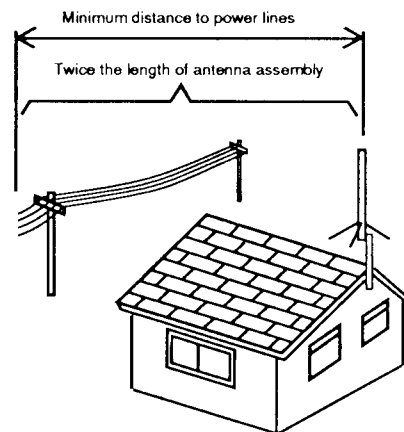

- Do not attempt to install the antenna by yourself if you do not have any experience in installing base station antenna. Ask your experienced friends or professional for help.
- Do not attempt to install the antenna at a location where does not have enough distance from nearby electric power lines. It is advised to install the antenna at least twice of total antenna height from nearby electric power lines.
- Do not install the antenna on any type of tower, pole or telescopic mast which exceeds 30 feet high, if you do not have enough experience in installing the antenna on that kind of location. Ask your experienced friends or professional for help.
- Do not use more than 1/10' section if you install the antenna on iron plumber's pipe. Attach guy wire if multiple pipes are used to install the antenna.

DIAMOND ANTENNA CORPORATION

15-1, I-chome, Sugamo Toshima-ku, Tokyo 170, Japan Phone : (03)3947-1411 Telex : 272 2420 DIATNAJ Cable Address : DIANTNA